

GROUP D

ALIGN TAPE ON THIS
EDGE OF SLOT-

BEFORE ASSEMBLY

00	7234	RELEASED FOR PRODUCTION	4/19/02 DF
NO.	ECO NO.	REVISIONS	DATE/BY
 COIN MECHANISMS INC. 400 REGENCY DR. GLENDALE HEIGHTS, IL 60139		TOLERANCES NOT SPECIFIED FRACTIONS= ± 1/64 ANGLES= ± 1° .XX= ± .010 .XXX= ± .005 HOLE DIA.= ± .002	TITLE DEFENDER
		DRAWN DF APP DWG NO. 0992-00001	DATE 4/19/02 DATE DATE
This drawing is the property of and contains proprietary information of Coin Mechanisms Inc. The drawing shall be returned upon request and is not to be copied or disclosed without written authorization and will not be used in any way detrimental to the interest of Coin Mechanisms.		CRITICAL SYMBOLS ▼ = CUSTOMER ▼ = PROCESS ▼ = BOTH	FINISH: SIZE: B SCALE: SHT 1 OF 1

"PLUG-IN"
FOR
RAIL OPTICS

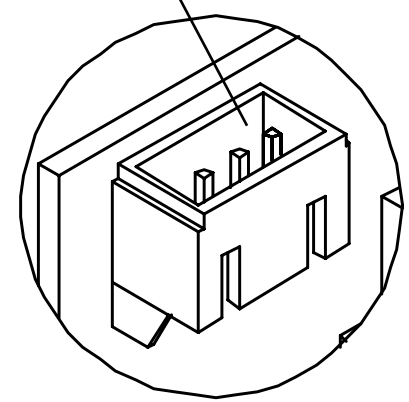

"PLUG-IN" DETAIL 1

33

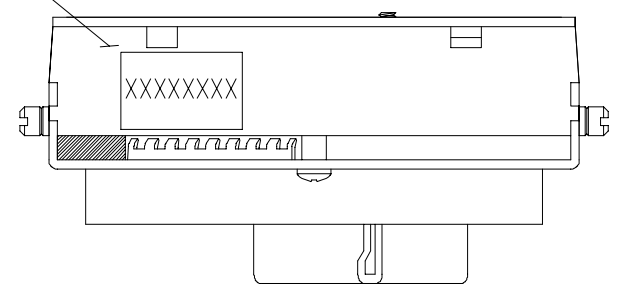

GROUP G

"PLUG-IN" FOR
EXIT SENSOR

"PLUG-IN" FOR
ACCEPT COIL

"PLUG-IN" FOR
TAPE SENSOR

"PLUG-IN" FOR
SENSOR COIL

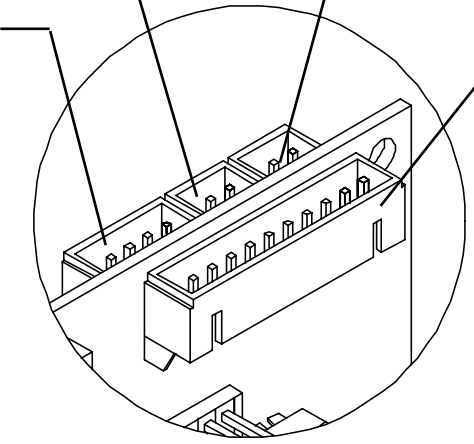

"PLUG-IN" DETAIL 2

4

GROUP G

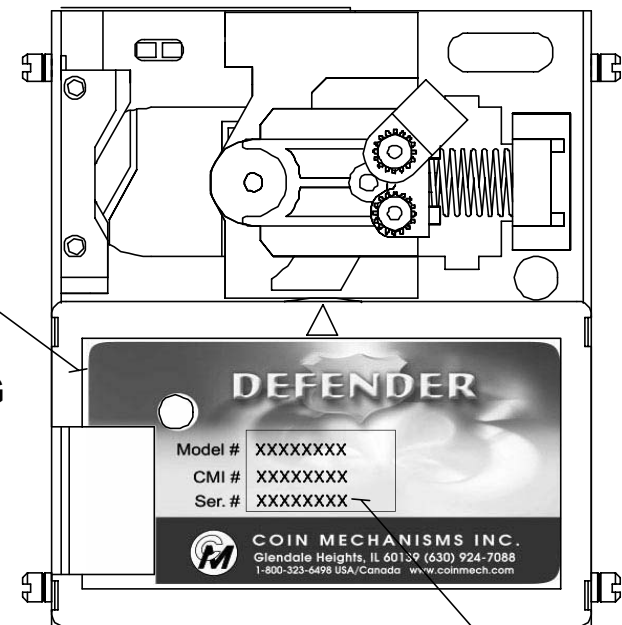

FRONT VIEW

GROUP G

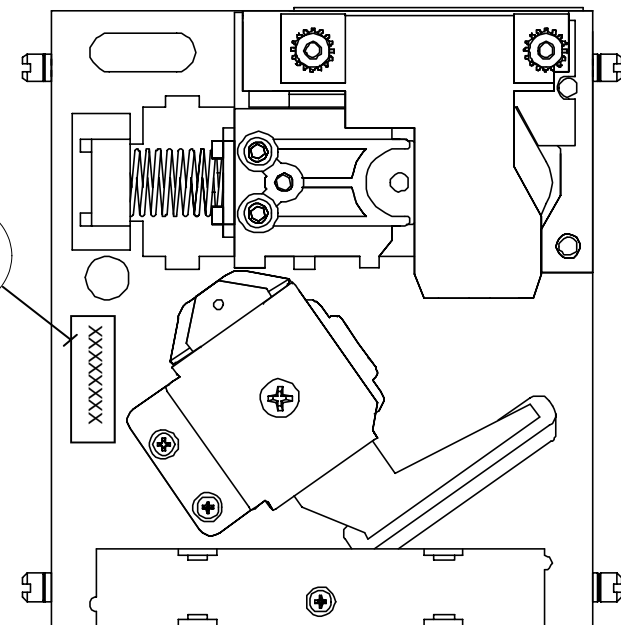

6

34



REAR VIEW

GROUP D

NO.		ECO NO.		SEE SHEET 1			DATE/BY	
		REVISIONS			TITLE			
					DEFENDER			
		 COIN MECHANISMS INC. 400 REGENCY DR. GLENDALE HEIGHTS, IL 60139			TOLERANCES NOT SPECIFIED FRACTIONS= ± 1/64 ANGLES= ±1° .XX= ±.010 .XXX= ±.005 HOLE DIA.= ±.002		DRAWN DF DATE 4/19/02 CHKO DATE APP DATE	
		This drawing is the property of and contains proprietary information of Coin Mechanisms Inc. The drawing shall be returned upon request and is not to be copied or disclosed without written authorization and will not be used in any way detrimental to the interest of Coin Mechanisms.			CRITICAL SYMBOL 		DWG NO. 0992-000001 FINISH: N/A SHT 2 OF 2	
		SIZE: B N/A						